

***HIKVISION***

















# Network Camera

Quick Start Guide



User Manual

## Symbols and Marks

	Notice		<ul style="list-style-type: none"> <li>i. Not necessarily included accessory.</li> <li>ii. Variable accessory amount.</li> <li>iii. Skip this step if not required.</li> </ul>
	Warning	microSD 	MicroSD card
	Forbidden		Purchase separately
	Correct		Disposal
	Incorrect		Functional grounding
	Turn to page A and continue.		Grounding
	Other situations		Skip this step if not necessary
	Waterproof		Other situations omitted

## Activate and Access Network Camera



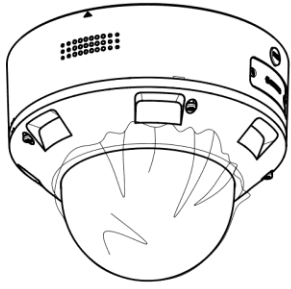

1x

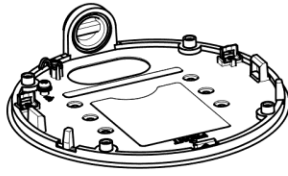

1x

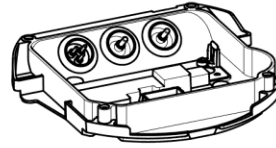

1x

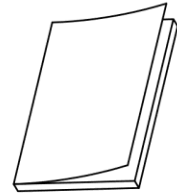

2x\*

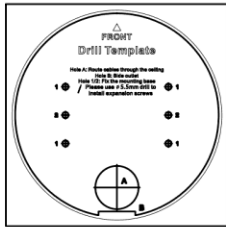

1x



PA4x25

1x

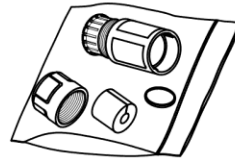

1x

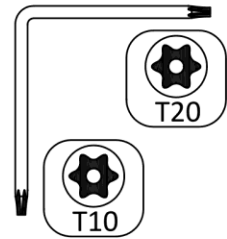

1x



1x

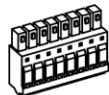

1x



1x



1x

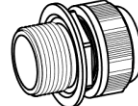

1x



1x



2x

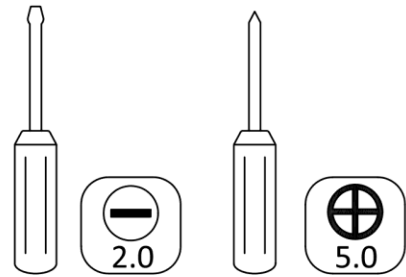
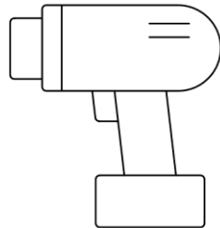
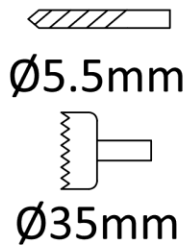

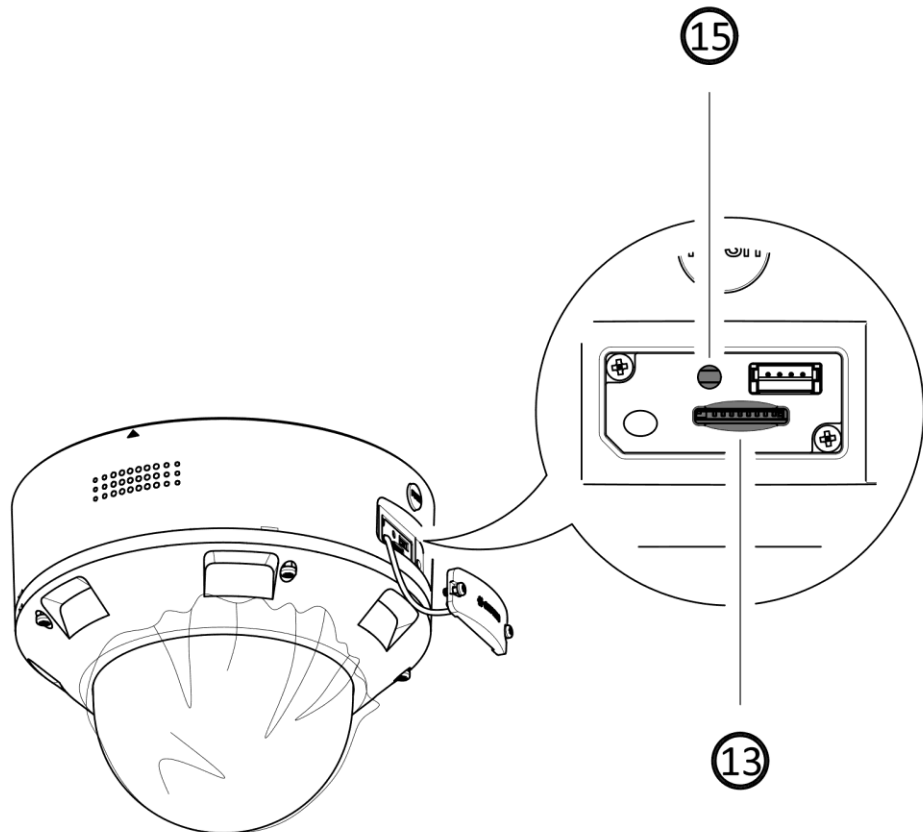
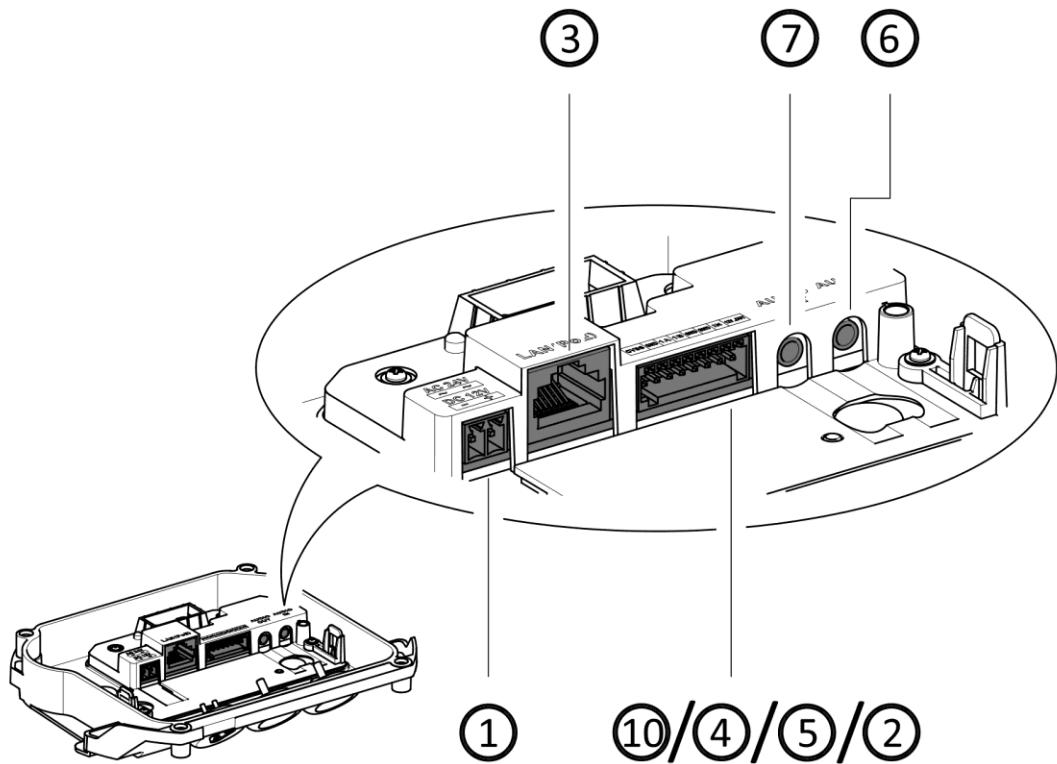

# 1.1

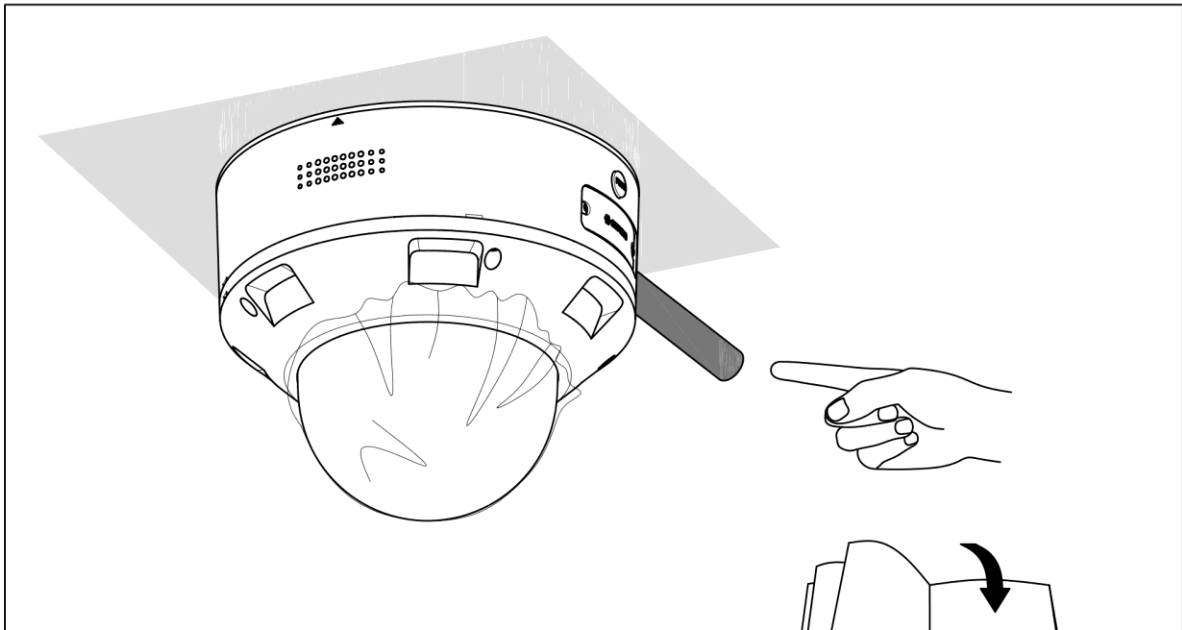
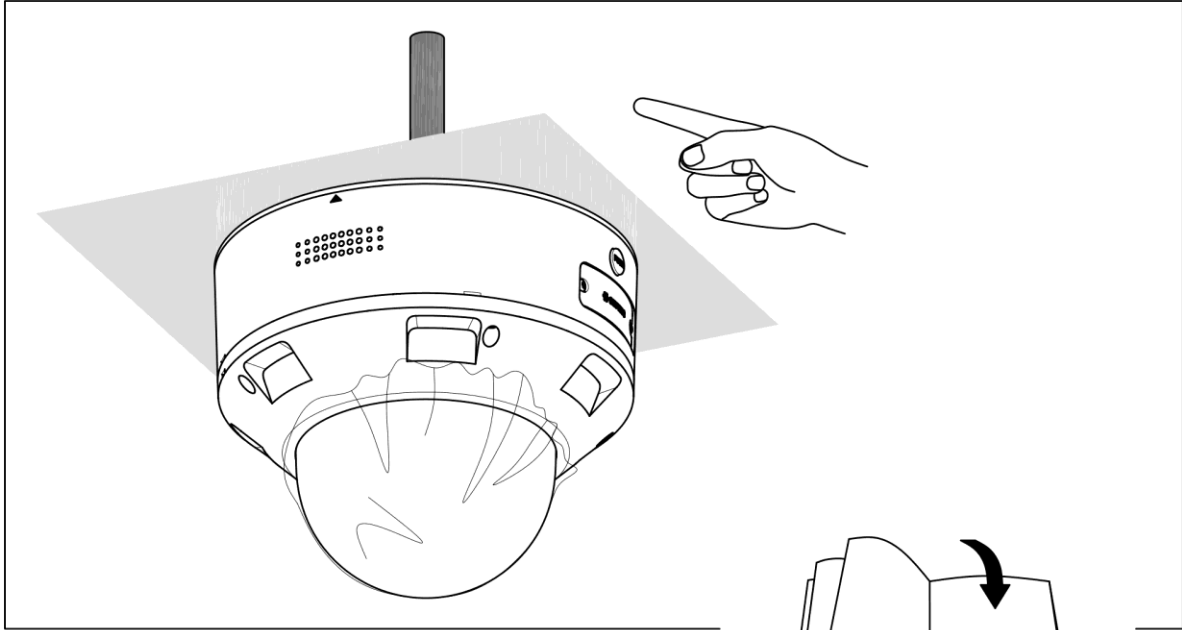

# A.1

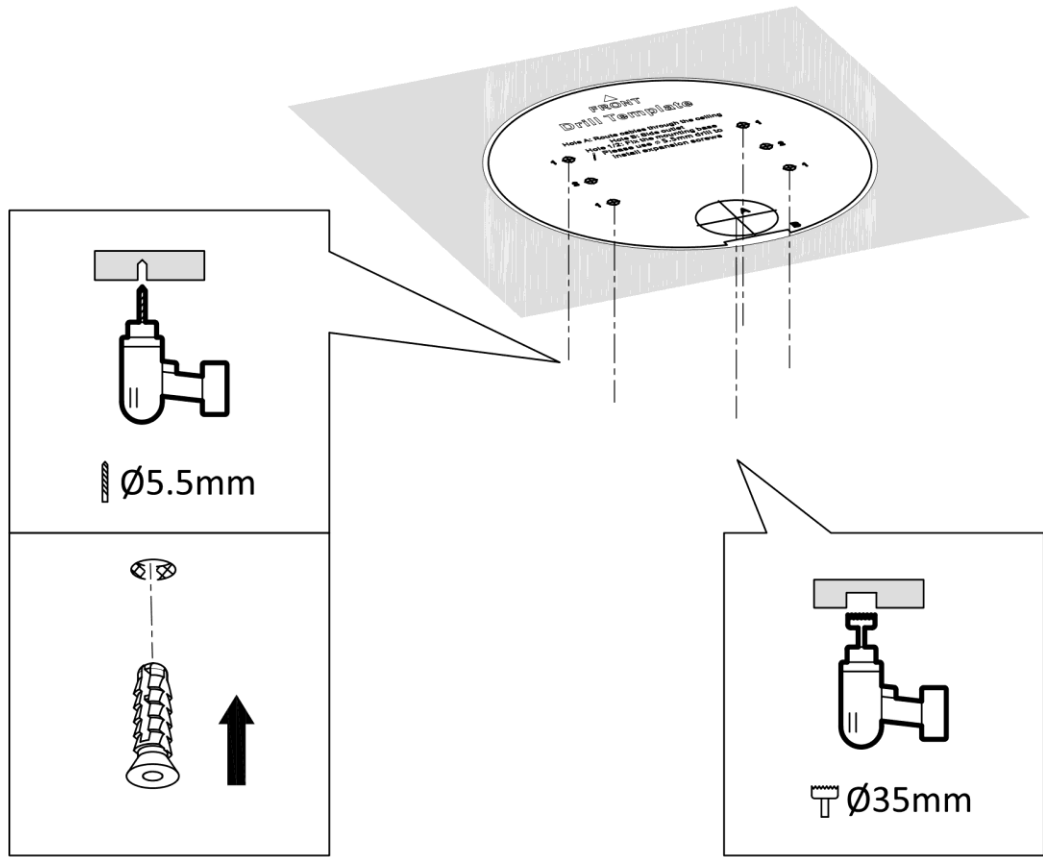

# A.2

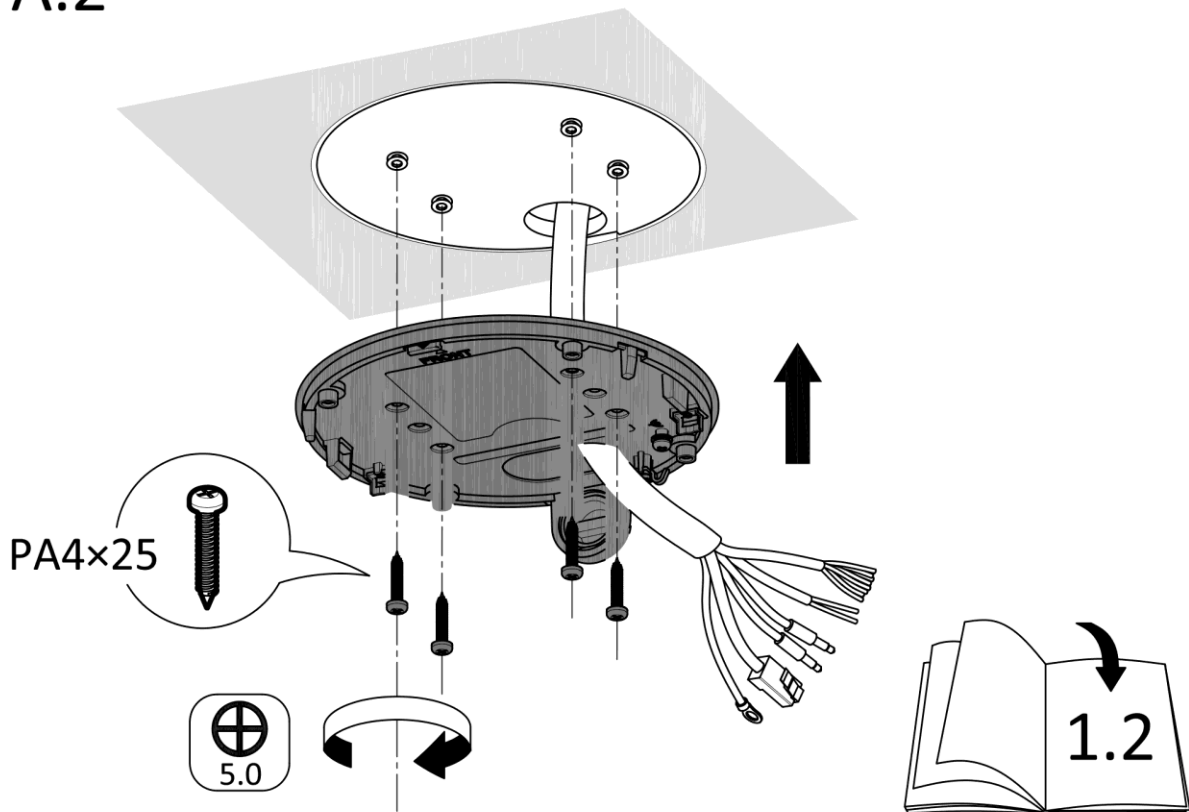



# B.3

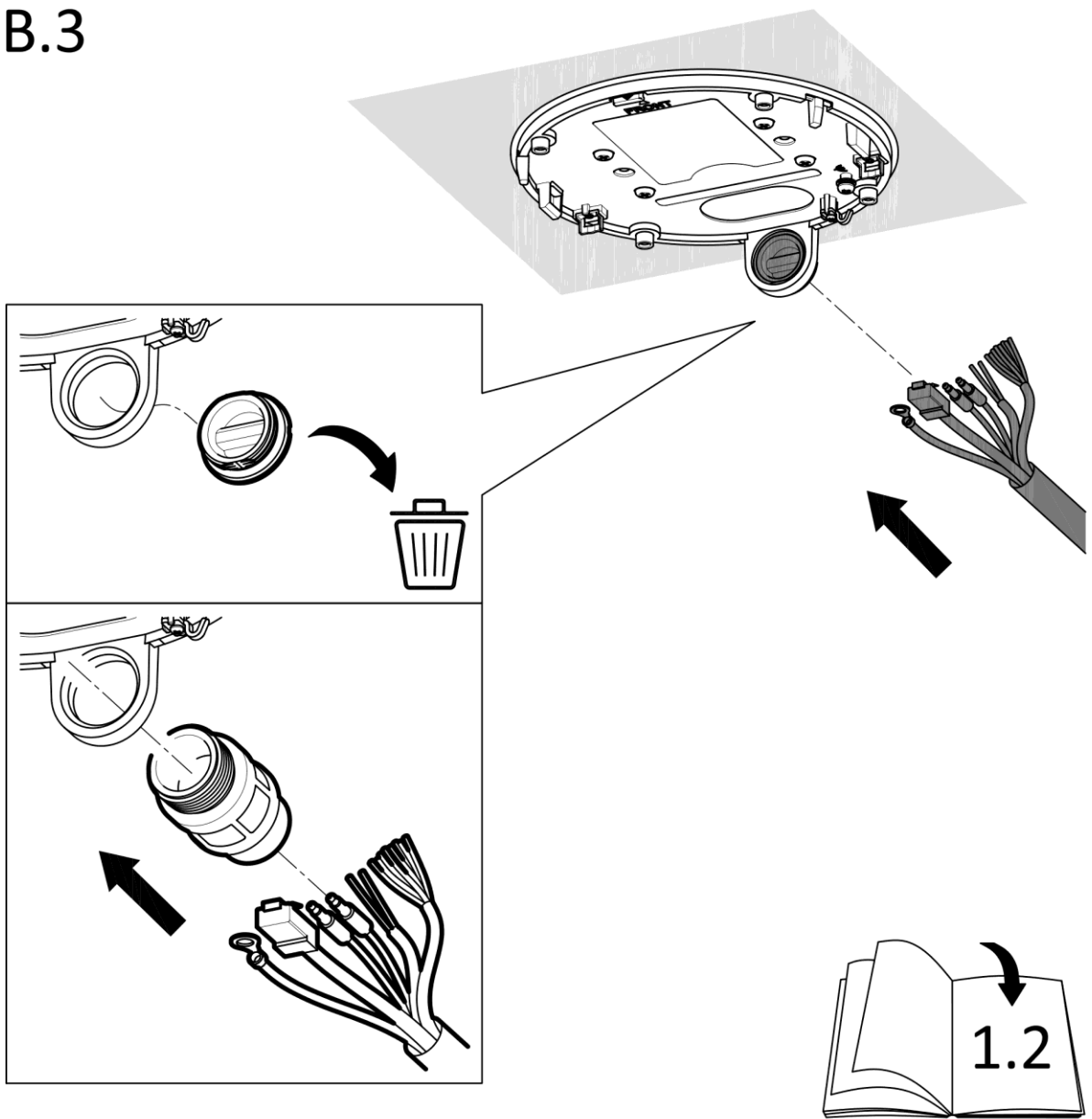

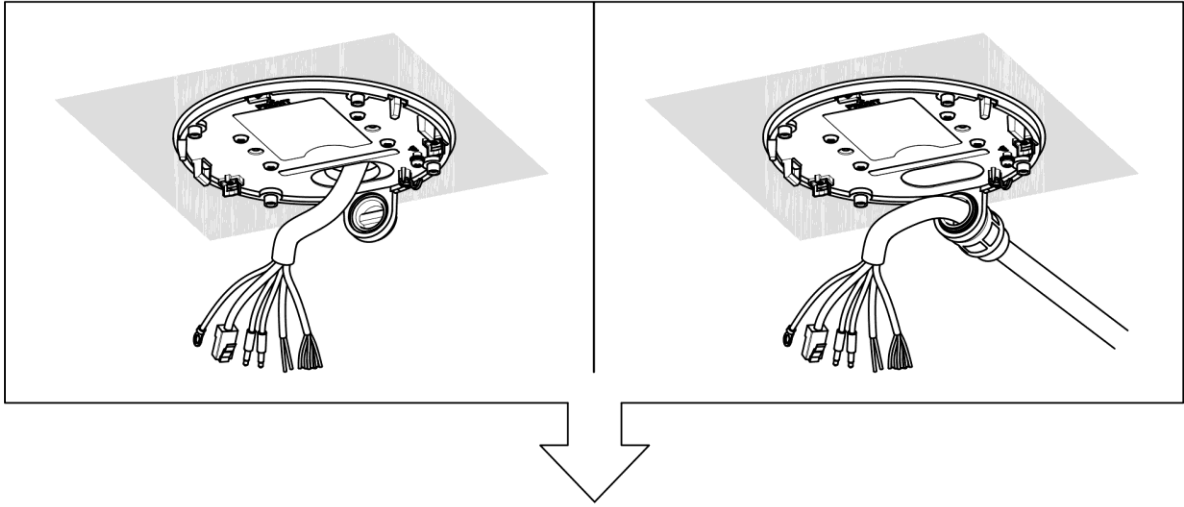

# 1.2

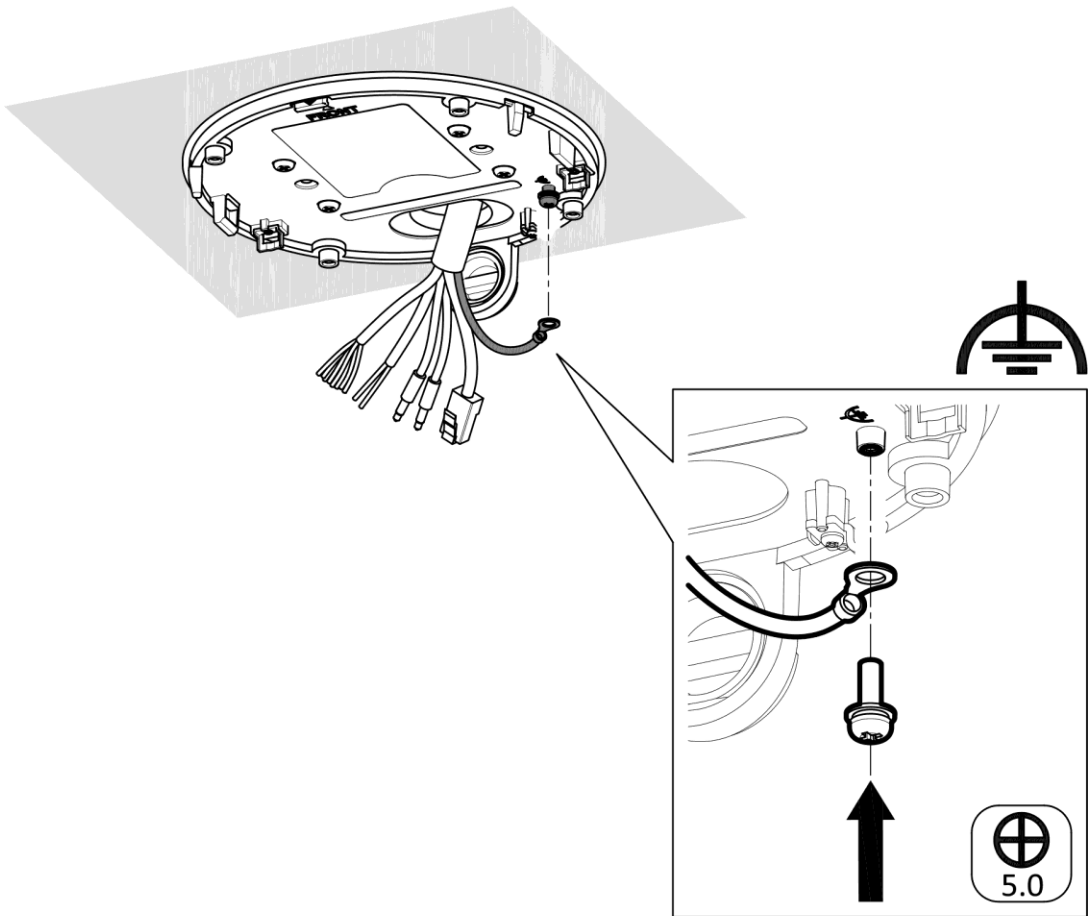

# 1.3

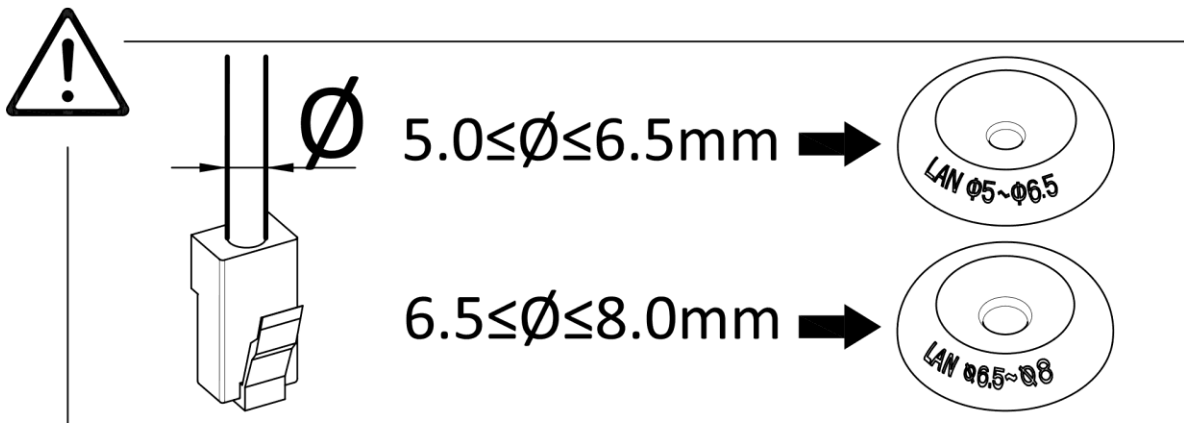
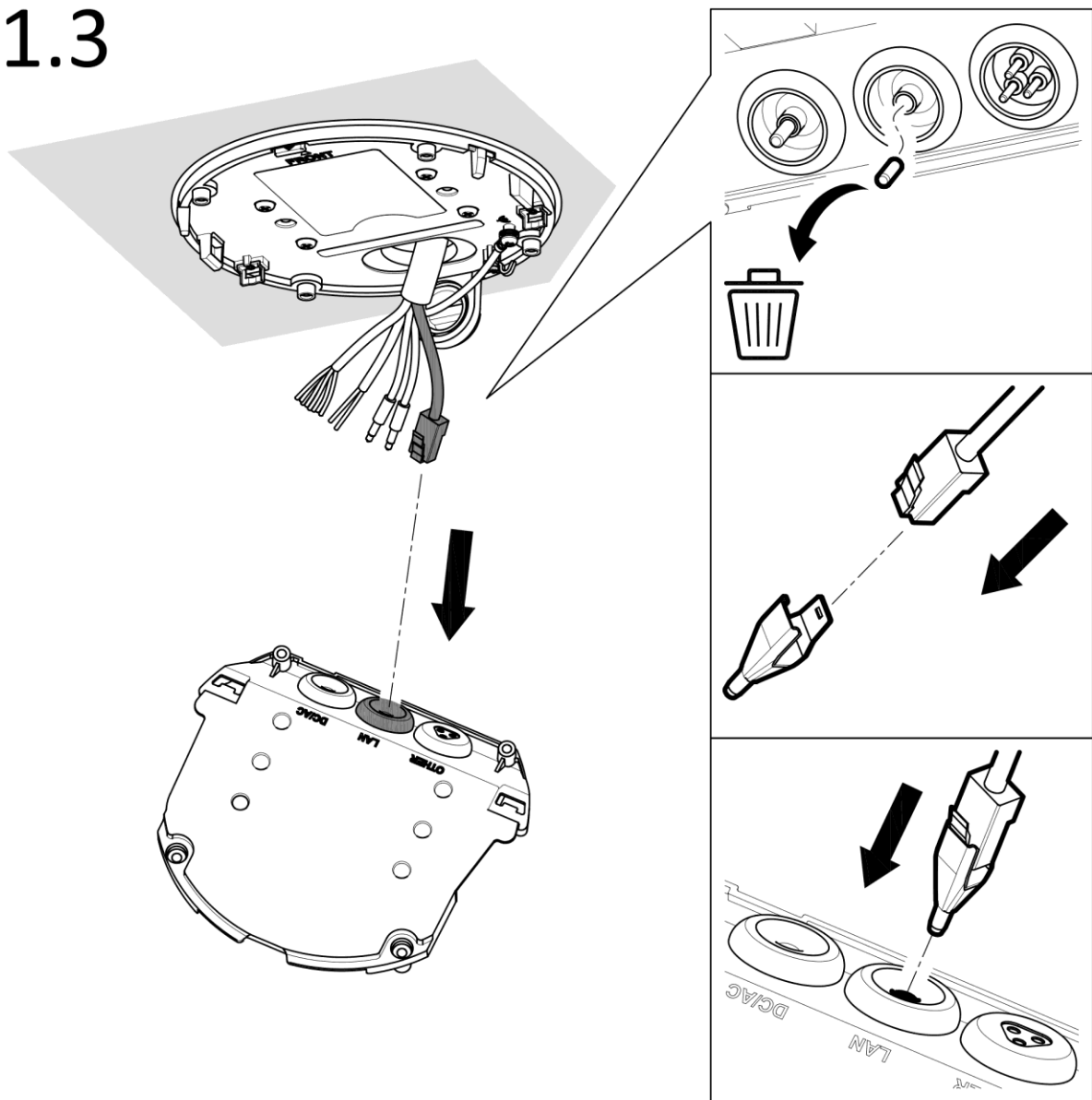

1.4

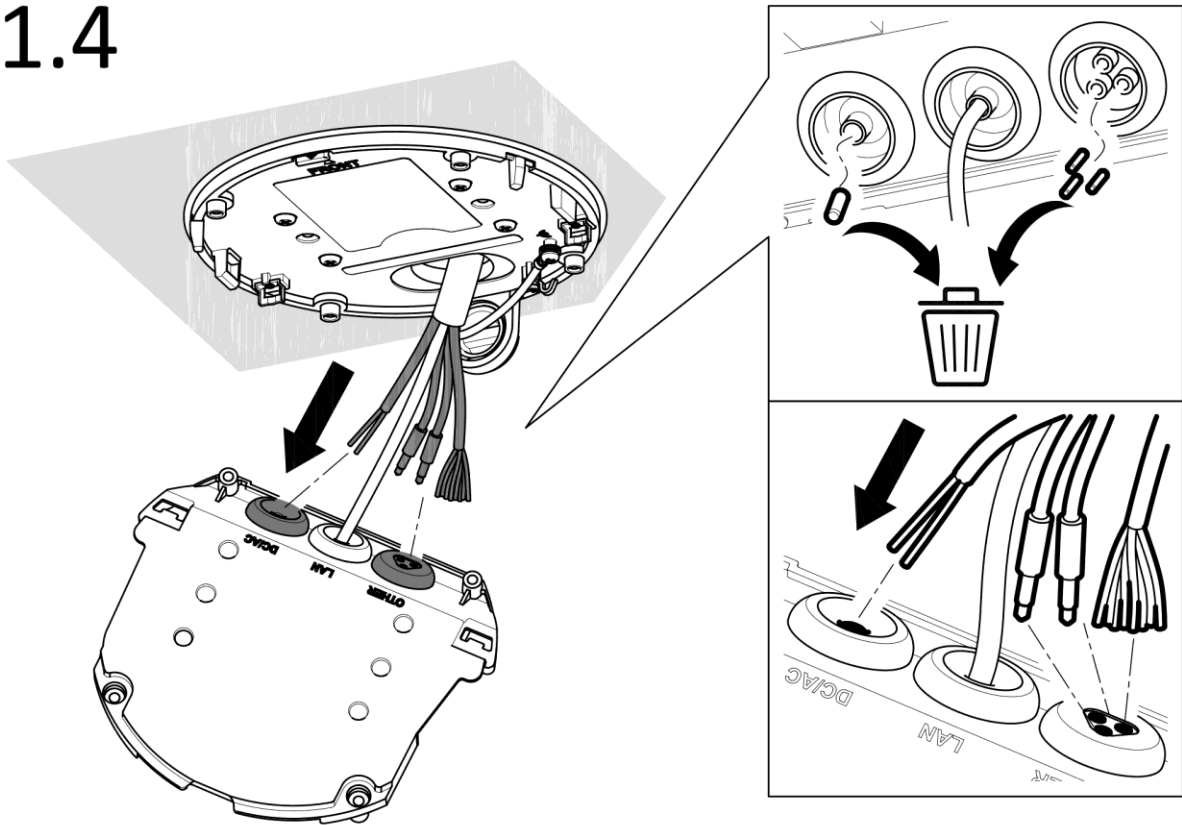

1.5

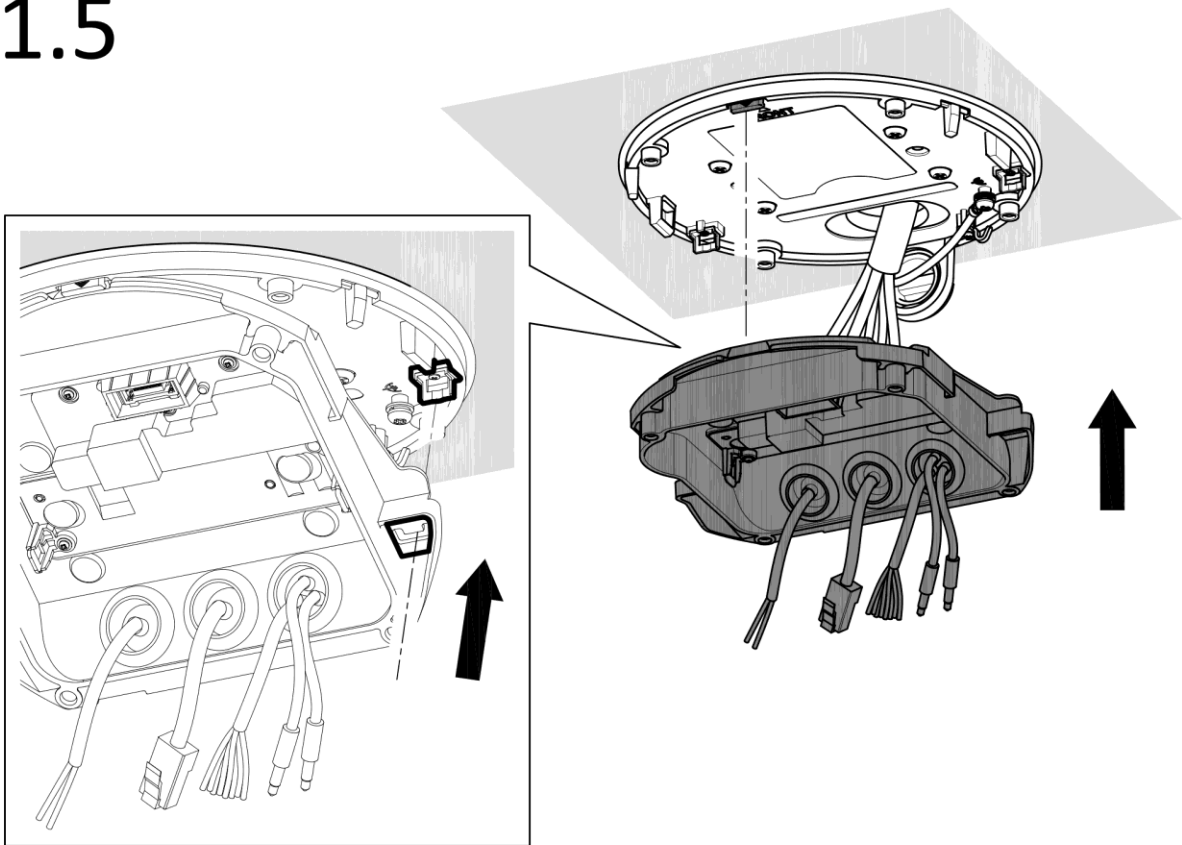

# 1.6

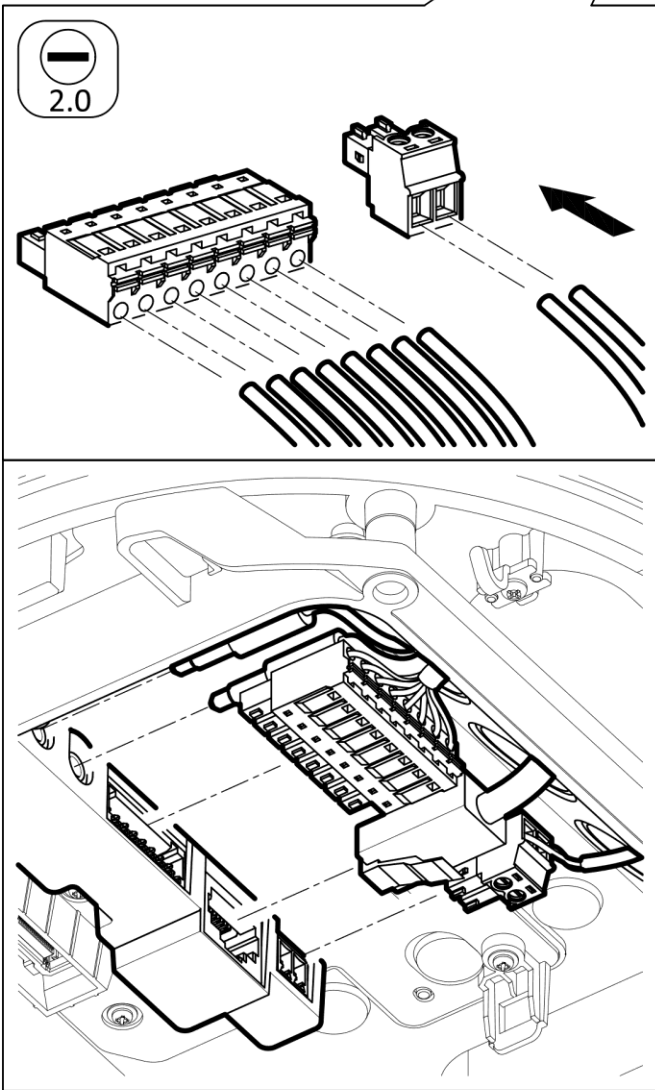
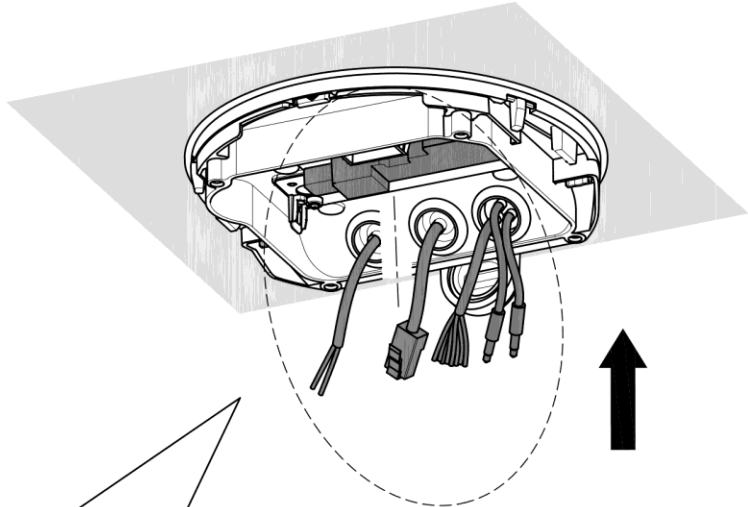

2.1

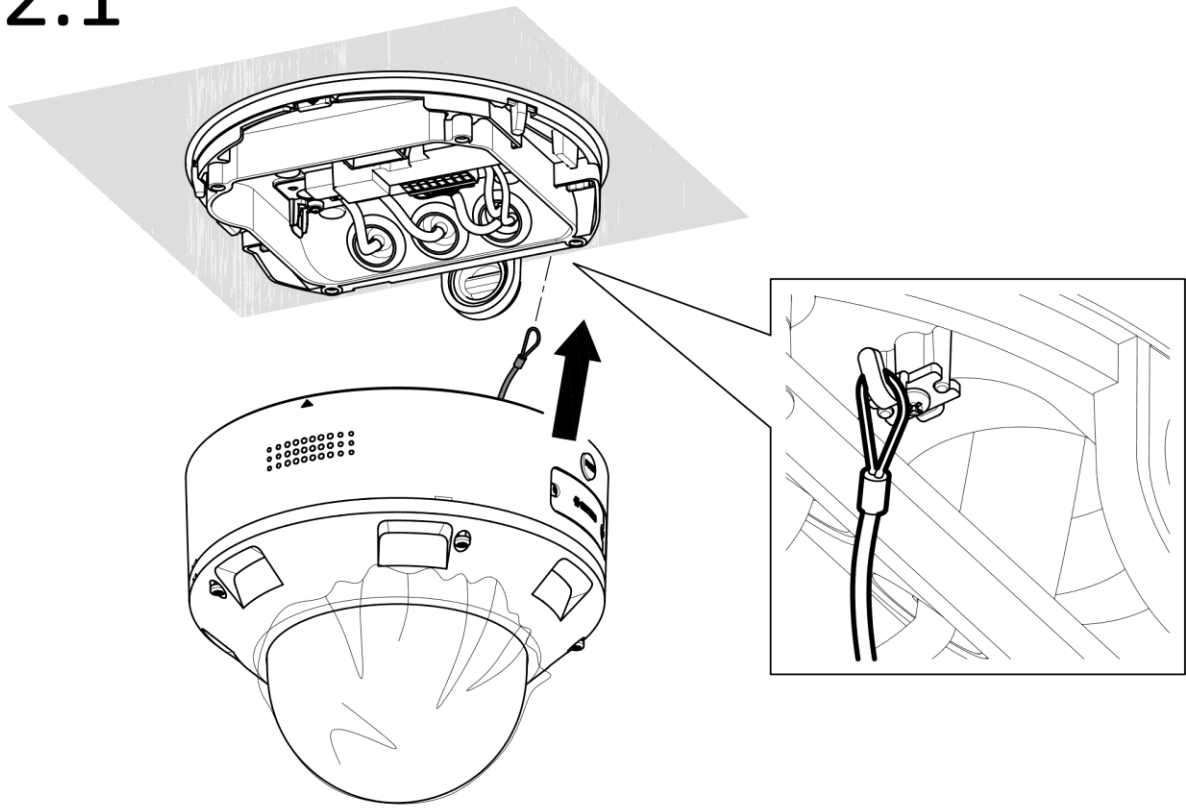

2.2

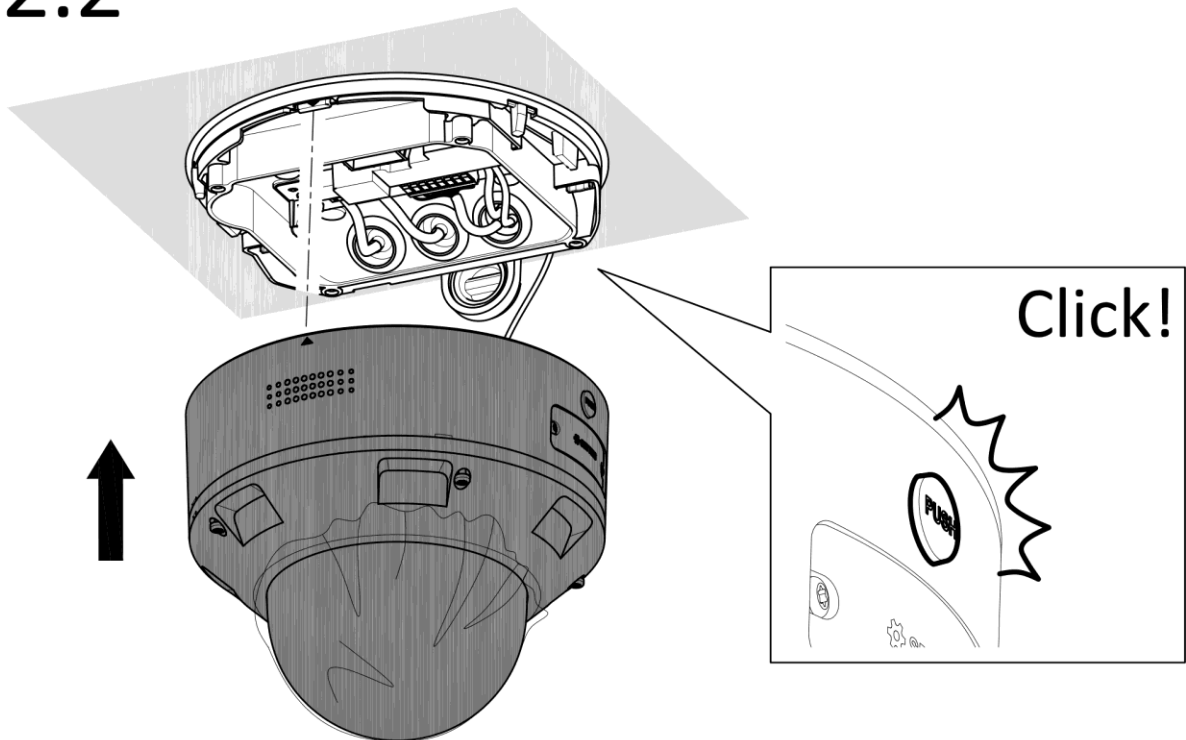

## 2.3

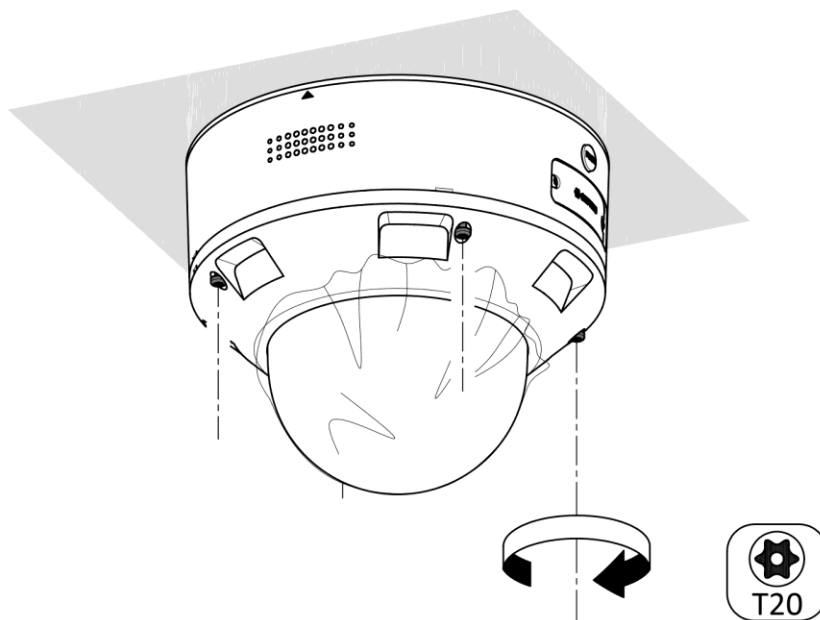

## 2.4

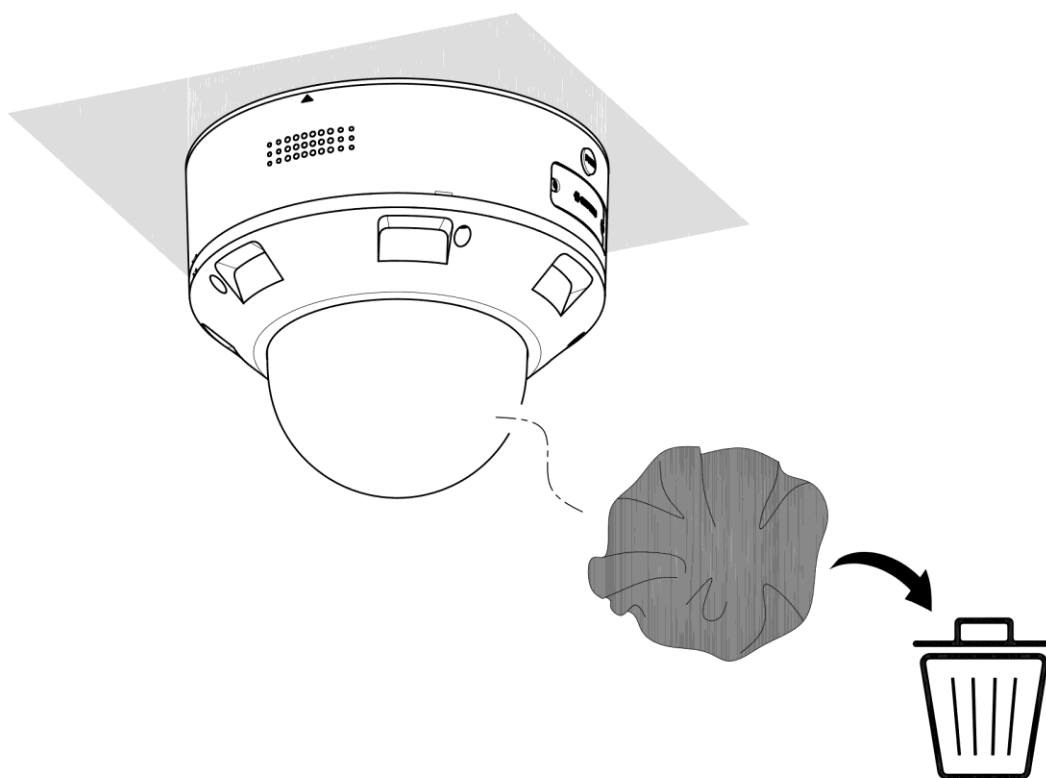

## Interface Introduction

1	Power input interface
2	Power output interface
3	Network interface
4	Alarm input interface
5	Alarm output interface
6	Audio input interface
7	Audio output interface
8	Built-in microphone
9	Built-in speaker
10	BNC/CVBS interface
11	HDMI interface
12	SDI interface
13	SD card slot
14	SIM card slot
15	Reset button
16	Fiber optical interface
17	Heater
18	USB
19	Antenna
20	RS-485
21	RS-232
22	ABF
23	Grounding
24	Wiegand interface
25	Solar panel
26	Battery switch
27	Debug power interface
28	Solar panel power interface
29	External solar panel interface
30	SOC debug serial port
31	MCU debug serial port
32	Video input interface
33	Video output interface
34	Aviation Plug
35	Battery power output interface
36	Debug network interface

**Note:** The interface varies with the models. Please refer to the product datasheet for details.



Product appearance is for reference only and may differ from the actual product.

**Note:** Refer to **Regulatory Compliance and Safety Information** accompanying the device for the compliance statement and safety information.



L'image du produit est donnée uniquement à titre de référence et le produit réel peut présenter un aspect différent.

**Remarque :** Consultez le document sur la **Conformité à la réglementation et consignes de sécurité** qui accompagne l'appareil pour en prendre connaissance.



Das Erscheinungsbild des Produkts dient nur als Referenz und kann vom tatsächlichen Produkt abweichen.

**Hinweis:** Beachten Sie **Informationen zur Einhaltung gesetzlicher Vorschriften und zur Sicherheit** im Lieferumfang des Gerätes für entsprechende Informationen.



La apariencia del producto es solo una referencia y puede diferir de la apariencia real del producto.

**Nota:** Consulte el documento **Cumplimiento normativo e Información de seguridad** que acompaña al dispositivo para conocer el cumplimiento normativo y información de seguridad relativa al mismo.



L'immagine del prodotto serve solo come riferimento e potrebbe differire dal prodotto effettivo.

**Nota:** Per la dichiarazione di conformità e le informazioni sulla sicurezza, consultare il documento **Conformità normativa e informazioni sulla sicurezza** incluso con il dispositivo.



A aparência do produto serve apenas de referência e pode ser diferente do produto real.

**Nota:** consulte a **Conformidade regulamentar e informações relacionadas com a segurança** que acompanham o dispositivo para obter a declaração de conformidade e as informações de segurança.



Het uiterlijk van het product is alleen bedoeld als referentie en kan verschillen van het werkelijke product.

**Opmerking:** Raadpleeg de bij het apparaat is geleverde **Informatie over naleving van regelgeving en veiligheid** voor de nalevingsverklaring en veiligheidsinformatie.



Vzhled výrobku slouží pouze jako reference a může se od skutečného výrobku lišit.

**Poznámka:** Prohlášení o shodě a bezpečnostní informace naleznete v dokumentu **Dodržování předpisů a bezpečnostní informace**, který se dodává spolu se zařízením.



Produktudseendet er kun til reference og kan variere fra det faktiske produkt.

**Bemærk:** Læs **Lovgivningsmæssig overensstemmelse og sikkerhedsoplysninger**, der følger med enheden, og som indeholder overensstemmelseserklæringen og sikkerhedsoplysninger.

 A termék megjelenése csak tájékoztató jellegű, és eltérhet a tényleges terméktől.

**Megjegyzés:** A megfelelőségi nyilatkozatot és a biztonsági információkat lásd a készülékhez mellékel **Jogsabályi megfelelés és biztonsági információk** dokumentumban.

 Rysunki przedstawiające wygląd produktu służą wyłącznie do celów referencyjnych i mogą różnić się od rzeczywistego wyglądu urządzenia.

**Uwaga:** Informacje dotyczące zgodności z przepisami i bezpieczeństwa podano w dostarczaną razem z urządzeniem broszurą **Informacje dotyczące zgodności z przepisami i bezpieczeństwa**.

 Aspectul produsului este doar de referință și poate varia de produsul real.

**Notă:** Consultați **Conformitatea cu reglementările și informații privind siguranța care însoțesc** dispozitivul pentru declarația de conformitate și informațiile de siguranță.

 Vzhľad produktu je len orientačný a môže sa líšiť od skutočného produktu.

**Poznámka:** Vyhlásenie o zhode s predpismi a bezpečnostné informácie nájdete v dokumente **Súlad s regulačnými predpismi a bezpečnostné informácie**, ktorý je priložený k zariadeniu.

 Tampilan produk hanya untuk referensi dan dapat berbeda dari tampilan produk yang sebenarnya.

**Catatan:** Lihat **Kepatuhan Terhadap Peraturan dan Informasi Keselamatan** yang disertakan pada perangkat untuk pernyataan kepatuhan dan informasi keselamatan.

 ပစ္စည်း ပုံသဏ္ဍာန်သည် ကိုးကားရန်အတွက်သာဖြစ်ပြီး ကုန်ပစ္စည်းအစစ်နှင့် ကွဲပြားမှု ရှိနိုင်ပါသည်။

**မှတ်ချက်-** လိုက်နာမှုဆိုင်ရာ ထုတ်ပြန်ချက်နှင့် ဘေးကင်းရေး အချက်အလက်များအတွက် စက်ပစ္စည်းတွင်ပါရှိသော

**စည်းမျဉ်းစည်းကမ်း လိုက်နာရန်နှင့် ဘေးကင်းရေး အချက်အလက်** ကို ကိုးကားပါ။

 Ürün görünümü sadece referans içindir ve gerçek ürün farklı olabilir.

**Not:** Uygunluk bildiri ve güvenlik bilgileri için cihazla birlikte verilen **Mevzuata Uygunluk ve Güvenlik Bilgileri** belgesine bakın.

 Внешний вид изделия зависит от конкретной модели. Рисунки приведены только для справки.

**Примечание.** Информацию о соответствии нормативным требованиям и технике безопасности см. в документе **Соответствие нормативным требованиям и инструкции по технике безопасности**, который поставляется вместе с устройством.

 Зовнішній вигляд виробу зображено лише для довідки; вигляд фактичного виробу може відрізнятися.

**Примітка:** Декларація відповідності нормативним вимогам та інформація щодо техніки безпеки містяться в документі **«Відповідність нормативним вимогам та інформація щодо техніки безпеки»**, який додається до пристрою.

مظهر المنتج للمرجعية فقط وقد يختلف عن المنتج الفعلي. 

**ملاحظة:** راجع الامتثال التنظيمي ومعلومات السلامة المرفقة بالجهاز لمعرفة بيان الامتثال ومعلومات السلامة.



See Far, Go Further

UD42445B