

DS-2DE5432IWG-E 4 MP 32 × Network IR Speed Dome



Hikvision DS-2DE5432IWG-E 4 MP 32× Network IR Speed Dome adopts 1/2.8" progressive scan CMOS chip. With the 32× optical zoom lens, the camera offers more details over expansive areas. This series of cameras can be widely used for wide ranges of high-definition, such as rivers, roads, railways, airports, squares, parks, scenic spots, and venues, etc.

- 1/2.8" Progressive Scan CMOS. High quality imaging with 4 MP resolution
- Focuses on human and vehicle targets classification based on deep learning
- Excellent low-light performance with powered-by-DarkFighter technology
- 32 × optical zoom and 16 × digital zoom provide close up views over expansive areas
- WDR, HLC, BLC, 3D DNR, defog, regional exposure, regional focus
- Expansive night view with up to 150 m IR distance
- 24 VAC & PoE (802.3at)
- Efficient H.265+/H.265 compression technology

▪ Specification

Camera	
Image Sensor	1/2.8" Progressive Scan CMOS
Max. Resolution	2560 × 1440
Min. Illumination	Color: 0.005 Lux @ (F1.5, AGC ON); B/W: 0.001 Lux @ (F1.5, AGC ON), 0 Lux with IR
Shutter Speed	1 s to 1/30,000 s
Day & Night	IR cut filter
Zoom	32x optional, 16x digital
Slow Shutter	Yes
Lens	
Focal Length	5.9 mm to 188.8 mm
FOV	Horizontal field of view: 60.2° to 2.0° (wide-tele), Vertical field of view: 35.2° to 1.1° (wide-tele), Diagonal field of view: 67.4° to 2.3° (wide-tele)
Focus	Auto, semi-auto, manual
Aperture	Max. F1.5
Zoom Speed	Approx. 5.6 s
Illuminator	
Supplement Light Type	IR
Supplement Light Range	IR Distance: up to 150 m
PTZ	
Movement Range (Pan)	360°
Movement Range (Tilt)	-15° to 90° (auto flip)
Pan Speed	Pan speed: configurable from 0.1° to 120°/s; preset speed: 120°/s
Tilt Speed	Tilt speed: configurable from 0.1° to 80°/s, preset speed 80°/s
Proportional Pan	Yes
Presets	300
Preset Freezing	Yes
Patrol Scan	8 patrols, up to 32 presets for each patrol
Pattern Scan	4 pattern scans
Park Action	Preset, pattern scan, patrol scan, auto scan, tilt scan, random scan, frame scan, panorama scan
3D Positioning	Yes
PTZ Status Display	Yes
Scheduled Task	Preset, pattern scan, patrol scan, auto scan, tilt scan, random scan, frame scan, panorama scan, dome reboot, dome adjust, aux output
Power-off Memory	Yes
Video	
Main Stream	50 Hz: 25 fps (2560 × 1920, 1920 × 1080, 1280 × 960, 1280 × 720), 60 Hz: 24 fps (2560 × 1920, 1920 × 1080, 1280 × 960, 1280 × 720)
Sub-Stream	50 Hz: 25 fps (704 × 576, 640 × 480, 352 × 288) 60 Hz: 24 fps (704 × 576, 640 × 480, 352 × 288)
Third Stream	50 Hz: 25 fps (1920 × 1080, 1280 × 960, 1280 × 720, 704 × 576, 640 × 480, 352 × 288) 60 Hz: 24 fps (1920 × 1080, 1280 × 960, 1280 × 720, 704 × 480, 640 × 480, 352 × 240)

Video Compression	Main stream: H.265+/H.265/H.264+/H.264 Sub-stream: H.265/H.264/MJPEG Third stream: H.265/H.264/MJPEG
Video Bit Rate	32 Kbps to 16 Mbps
H.264 Type	Baseline profile/Main profile/High profile
H.265 Type	Main profile
Scalable Video Coding (SVC)	H.264 and H.265 encoding
Region of Interest (ROI)	8 fixed regions for each stream
Audio	
Audio Compression	G.711,G.722.1,G.726,MP2L2,PCM,MP3,AAC-LC
Audio Bit Rate	64 Kbps (G.711),16 Kbps (G.722.1),16 Kbps (G.726),32 to 192 Kbps (MP2L2),16 to 64Kbps (AAC-LC),8 to 320 Kbps (MP3)
Audio Sampling Rate	8 kHz/16 kHz/32 kHz/48 kHz
Environment Noise Filtering	Yes
Network	
Protocols	IPv4/IPv6, HTTP, HTTPS, 802.1x, Qos, FTP, SMTP, UPnP, SNMP, DNS, DDNS, NTP, RTSP, RTP, TCP/IP, UDP, IGMP, ICMP, DHCP, PPPoE, Bonjour,WebSocket,WebSockets
Simultaneous Live View	Up to 20 channels
API	ONVIF (Profile S, Profile G, Profile T),ISAPI,SDK,ISUP
User/Host	Up to 32 users; 3 user levels: administrator, operator, and user
Security	Password protection, complicated password, HTTPS encryption, 802.1X authentication (EAP-TLS, EAP-LEAP, EAP-MD5), watermark, IP address filter, basic and digest authentication for HTTP/HTTPS, control timeout settings, security audit log, TLS 1.2, host authentication (MAC address)
Network Storage	NAS (NFS, SMB/CIFS), auto network replenishment (ANR)
Client	iVMS-4200, HikCentral Pro, Hik-Connect
Web Browser	IE11, Chrome 80+, Firefox 80+, Safari 13+, Edge 89+
Image	
Image Parameters Switch	Yes
Image Settings	Saturation, brightness, contrast, sharpness, gain, and white balance adjustable by client software or web browser
Day/Night Switch	Day, Night, Auto, Schedule
Wide Dynamic Range (WDR)	120 dB
SNR	> 52 dB
Defog	Digital Defog
Image Stabilization	No
Image Enhancement	BLC, HLC, 3D DNR
Privacy Mask	24 programmable polygon privacy masks, mask color or mosaic configurable
Regional Focus	Yes
Regional Exposure	Yes
Interface	
Ethernet Interface	1 RJ45 10M/100M self-adaptive Ethernet port
On-board Storage	Built-in memory card slot, support microSD/microSDHC/microSDXC card, up to 512 GB
Audio	1 input (line in), max. input amplitude: 2-2.4 vpp, input impedance: 1 K Ω \pm 10%; 1 output (line out), line level, output impedance: 600 Ω
Alarm	2 inputs, 1 output

Reset	Yes
Event	
Basic Event	Motion detection, video tampering alarm, exception, alarm input and output
Smart Event	Line crossing detection, intrusion detection, region entrance detection, region exiting detection, unattended baggage detection, object removal detection, audio exception detection
Linkage	Upload to FTP/NAS/memory card, notify surveillance center, send email, trigger alarm output, trigger recording, and PTZ actions (such as preset, patrol scan, pattern scan)
Deep Learning Function	
Face Capture	Detects up to 5 faces simultaneously. Supports detecting, capturing, grading, selecting of face in motion, and output the best face picture of the face
General	
Power	DS-2DE5432IWG-E: 24 VAC, Max. 24 W (including max. 9 W for IR and max. 1.6 W for heater); PoE (802.3at) DS-2DE5432IWG-E(B): 36 VDC ± 25%, max. 24 W, PoE (802.3at)
Dimension	∅ 210 mm × 344.7 mm (∅ 8.27" × 13.57")
Weight	Approx. 3.0 kg (6.61 lb.)
Material	Metal
Operating Condition	-30 °C to 65 °C (-22 °F to 149 °F). Humidity 90% or less (non-condensing)
Demist	Yes
Approval	
EMC	CE-EMC (EN 55032: 2015, EN 61000-3-2: 2019, EN 61000-3-3: 2013 + A1: 2019, EN 50130-4: 2011 + A1: 2014), RCM (AS/NZS CISPR 32: 2015), IC (ICES-003: Issue 7), KC (KN 32: 2015, KN 35: 2015)
Safety	UL (UL 62368-1); CB (IEC 62368-1:2014+A11); CE-LVD (EN 62368-1:2014/A11:2017)
Environment	CE-RoHS (2011/65/EU); WEEE (2012/19/EU); Reach (Regulation (EC) No 1907/2006)
Protection	IP66 (IEC 60529-2013), TVS 6000V lightning protection, surge protection and voltage transient protection

▪ DORI

The DORI (detect, observe, recognize, identify) distance gives the general idea of the camera ability to distinguish persons or objects within its field of view.

It is calculated based on the camera sensor specification and the criteria given by EN 62676-4: 2015.

DORI	Detect	Observe	Recognize	Identify
Definition	25 px/m	63 px/m	125 px/m	250 px/m
Distance (Tele)	2400.0 m (7874.0 ft)	952.4 m (3124.7 ft)	480.0 m (1574.8 ft)	240.0 m (787.4 ft)

▪ Available Model

DS-2DE5432IWG-E

DS-2DE5432IWG-E(B)

▪ Dimension

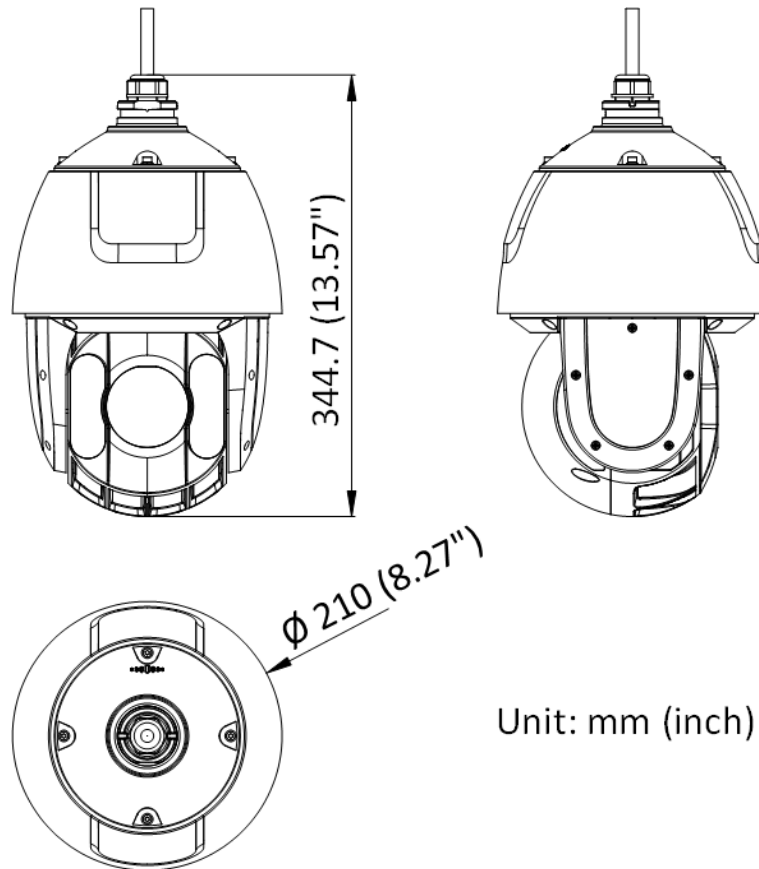















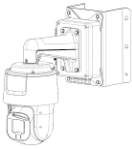



▪ **Accessory**

▪ **Included**

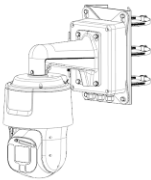
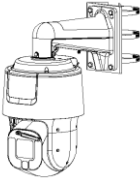
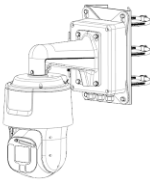

▪ **Optional**

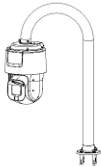
DS-1604ZJ-BOX-CO RNER Wall mount	DS-1604ZJ-box Wall mount	DS-1661ZJ Pendant Mount	DS-1662ZJ Pendant Mount	DS-1673ZJ Vertical pole mount
--	-----------------------------	----------------------------	----------------------------	----------------------------------

				
				
DS-1604ZJ-BOX-PO LE Vertical pole mount	DS-1684ZJ Vertical pole mount	DS-1604ZJ-pole Vertical pole mount	DS-1663ZJ In-ceiling mount	DS-1619ZJ Others
				
				
DS-1602ZJ-R/B Wall mount for PTZ camera with built-in audio, alarm and blue & red light	DS-1661ZJ-R/B Pendant Mount for PTZ camera with built-in audio, alarm and blue & red light			
				

Headquarters

No.555 Qianmo Road, Binjiang District,
Hangzhou 310051, China
T +86-571-8807-5998
www.hikvision.com



Follow us on social media to get the latest product and solution information.

